

VENUS Rugged 3.5 Inch SBC with 7th Gen Core i7 CPU and PCIe/104

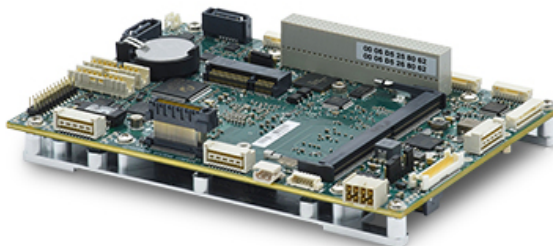

FEATURES

- Intel "Kaby Lake" 7th Gen Core i7-7660U 2.8GHz
- 4GB DDR4 RAM soldered on board
- Expansion socket for up to 16GB additional / 20GB total RAM
- 2x Gigabit Ethernet
- 2x SATA 3.0 ports + mSATA socket
- VGA, HDMI & dual channel LVDS with 3 simultaneous independent display support
- 4x RS-232/422/485 ports
- 6x USB 2.0 ports
- 4x USB 3.0 ports
- HD audio
- 16 GPIO lines with 3.3/ 5V logic levels
- TPM module
- CSI camera serial interface
- 2x PCIe MiniCard sockets; one socket supports mSATA
- OneBank-Plus PCIe/104 + PCI-104 expansion socket
- +9-18VDC input voltage
- 14W power consumption typical
- 3.5 inch form factor: 5.75" x 4.0" (146mm x 102mm)
- 40°C to +85°C operating temperature
- Bottom-mounted heat spreader cooling

Based on the "Kaby Lake" 7th generation Core i7 processor, Venus offers high CPU performance in a small form factor rugged SBC with modest power consumption. It incorporates a full suite of rugged features such as soldered memory, latching connectors, a thicker PCB, and true -40/+85°C operating temperature, making it suitable for the most demanding vehicle applications. High I/O density, multiple expansion sockets, rugged design, modest power consumption of 14W, and wide temperature operation combine to make Venus an extremely attractive option for applications requiring high CPU performance or ruggedness.

◆ Block Diagram

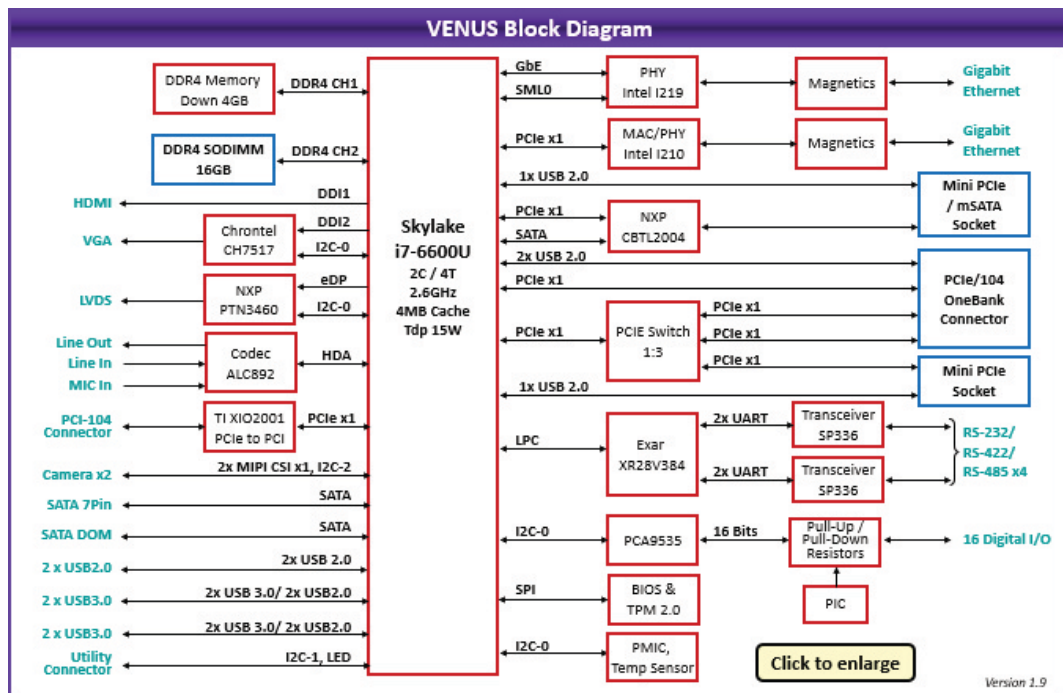

◆ Display Features

Venus supports 3 simultaneous independent displays, VGA, HDMI, and dual channel LVDS LCD. The HDMI port is capable of 4K screen resolution. Mass storage options include SATA DOM, mSATA, and a connector for an external SATA drive (all ports are SATA III capable). Diamond offers a series of MLC and SLC mSATA and SATA DOM modules with wide temperature qualification for use with Venus.

◆ Wide Range of I/O

The 3.5 inch form factor enables Venus to include an impressive range of I/O features on a single board while retaining a small form factor profile. Connectivity includes 4 RS-232/422/485 serial ports, 6 USB ports (4 are USB 3.0 capable), dual gigabit Ethernet ports, and 16 digital I/O lines.

The 4 serial ports support RS-232, RS-422, and RS-485 protocols. Protocol selection as well as all other configurations are fully software programmable and may be configured in the BIOS for convenience or controlled via an application program. For RS-422 and RS-485, line termination resistors are also provided and are programmable.

◆ Development Support

Venus is available in a complete development kit that includes a Venus SBC, a cable kit, a SATA Disk-on-Module (SATA-DOM) with your choice of operating system pre-installed, and a backup USB flashdisk. Available operating systems are Linux Ubuntu 20.04 kernel 5.x 64-bit and Windows 10 64-bit. Other OS support is available by consultation. For customers who already have a Venus SBC or who have multiple boards, the programmed SATA-DOM and backup USB flash are also available as an SDK.

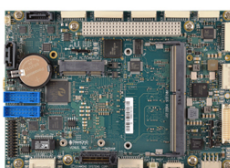

Venus



Venus Cable kit

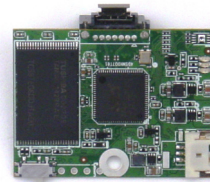

SATA DOM

◆ Cable Kit

The Venus cable kit CK-VNS-05 includes cables for all I/O connectors. This version of the kit includes rugged latching cables for the USB 3.0 ports.

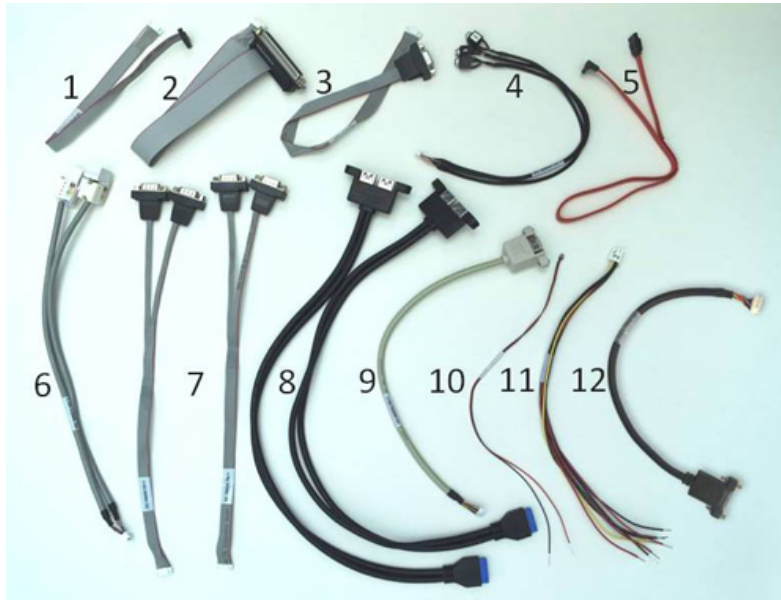

CK-VNS-05 includes the following cables:

No.	Qty	Cable	Description	Drawing
1	1	6980514	Cable, Utility, 2x6 2mm IDC Socket	Show
2	1	6980517	Digital I/O cable, DB37F connector	Show
3	1	6980507	Cable, VGA, 1.25mm Con DE15 Female	Show
4	1	6980508	Cable, Audio, 1.25mm 2X 3.5mm	Show
5	1	6989101	SATA Cable, 7-Pin Data, Straight to Right Angle, 500mm	Show
6	1	6980513	Cable, Dual Ethernet, 2x10 1.25mm	Show
7	2	6980500	Cable 1.25mm to 2x DB9M Serial	Show
8	2	6980610	Dual USB 3.1 type A cable with latching 2x10 2mm board connector	Show
9	1	6980503	Cable, 2xUSB 2.0, 1.25 Con	Show
10	1	6980524	External battery cable, discrete wires	Show
11	1	6980512	Power input cable, discrete wires	Show
12	1	6980519	Cable, HDMI to GHDR-20V 2x10 1.25mm	Show

◆ I/O Features

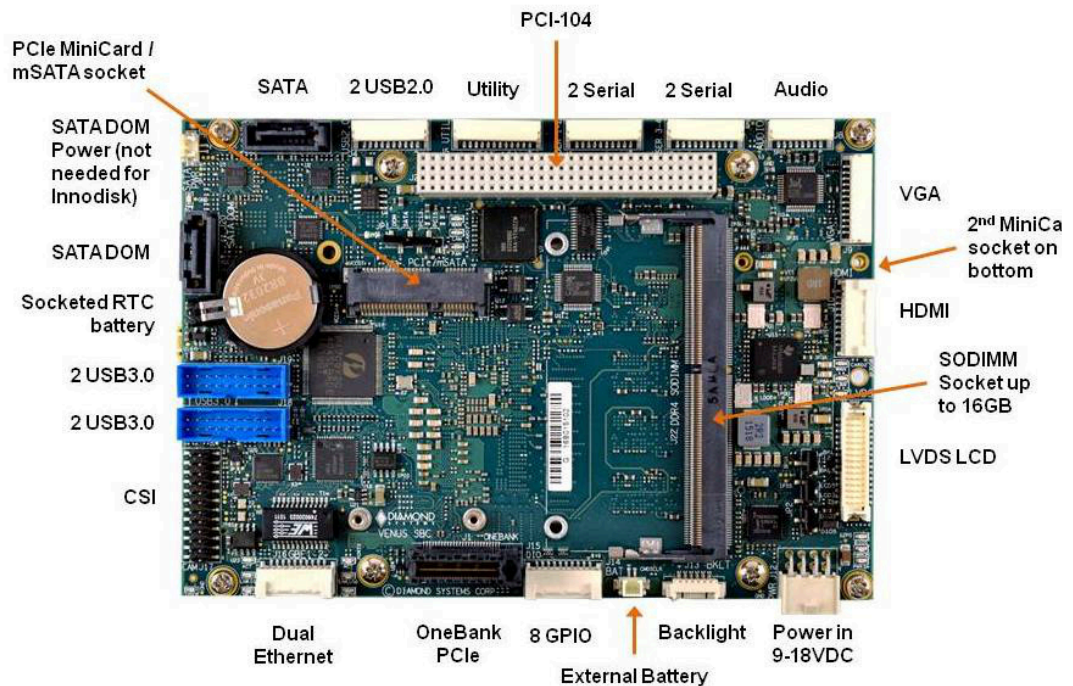

Venus has a SATA DOM socket and a second SATA connector. All ports are SATA III compliant.

A multi-use MiniCard socket auto-selects for either a PCIe MiniCard or mSATA flashdisk. This dual function socket can be used to add compact additional I/O or mass storage to your system. The dedicated SATA connector can be used with off-board SATA devices and also supports use of a board-mounted miniature SATA disk-on-module for a smaller overall system envelope with less cables. Most I/O on Venus utilizes latching I/O connectors for enhanced ruggedness and reliability. Venus has a SATA DOM socket and a second SATA connector. All ports are SATA III compliant.

Venus provides 4 RS-232/422/485 ports using multiprotocol transceivers, one per port. All configuration features are fully programmable as well as configurable in the BIOS screens, including protocol and line termination for RS-422/485. In RS-458 mode, both echo and no-echo modes are supported. The expansion connectors use 22mm stacking height to provide more clearance for installed minicards.

Venus supports two 10/100/1000 high speed Gigabit Ethernet ports derived from Intel I210IT PCIe Gigabit Ethernet controllers. A latching connector is used to bring these ports off board instead of RJ-45 jacks, optimizing space on the board and increasing ruggedness. Activity status of the Ethernet ports can be read from LEDs.

◆ Expansion Capability

In addition to the already high level of onboard I/O, Venus also provides great expansion flexibility, including both a OneBank Plus (PCIe/104 + PCI-104) socket and 2 full-size MiniCard sockets.

The compact OneBank expansion connector provides high performance PCIe expandability in a stacking format. The expansion connectors use 22mm stacking height to provide more clearance for installed minicards. It supports up to 3 PCIe/104 Type 1 and Type 2 add-on modules along with PCIe/104 OneBank I/O modules with PCIe x1 host interface, while conserving board space and reducing total system cost. [Learn more about the OneBank expansion connector.](#)

The companion PCI-104 connector supports PCI-104 modules for compatibility with an even greater array of I/O modules. Use of PC/104-Plus modules will require removing the PC/104 ISA connector to avoid interference with the OneBank connector.

The top side MiniCard socket supports full-size PCIe and USB MiniCards as well as mSATA Disk-on-Modules. The bottom side socket supports full-size and half-size PCIe MiniCards.

Mass storage options include the top side mSATA socket as well as a SATA-DOM socket. Flashdisk modules up to 256GB in wide temperature range are available for both sockets.

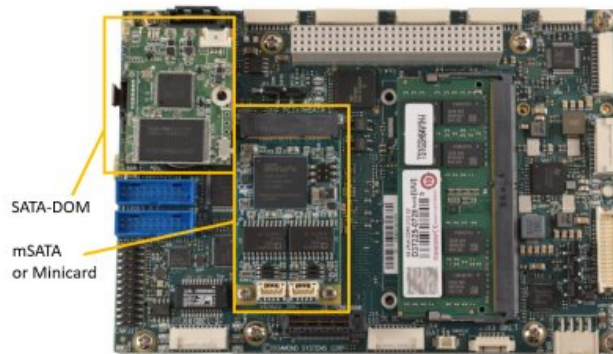

SATA-DOM and mSATA/minicard sockets on top side



Second half/full-size MiniCard socket available on bottom side

◆ Rugged Features

Venus incorporates a full suite of rugged features such as latching connectors, a thicker PCB, and soldered memory, making it suitable for the most demanding vehicle applications.

Most I/O connectors use a true locking design to ensure reliable operation in high vibration environments. The 50% thicker PCB along with 8 mounting points provides greater rigidity to minimize the possibility of solder joint failure from vibration.

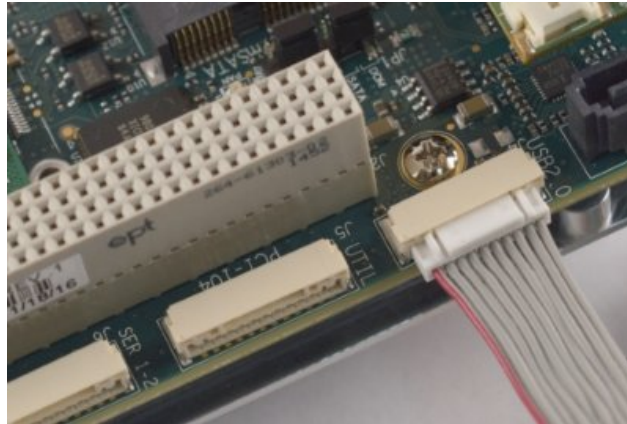

Positive latching connector system enhances ruggedness and reliability



Thicker PCB inhibits flexing from high vibration

Innovative Conduction Cooling

The bottom side heat spreader on Venus provides the most efficient cooling solution in a weight-optimized design, enabling Venus to run reliably at up to 85°C. The heat spreader conducts heat directly to the system chassis for maximum heat dispersion to the ambient environment and minimum radiation into the enclosure interior. By reducing the interior temperature, Venus helps to improve overall system reliability. In addition the bottom side heat spreader leaves the entire top side of the board free for expansion and memory modules, simplifying system configuration and maintenance.

The Venus heat spreader includes a number of innovations to provide system designers with flexibility and confidence. The bottom side contains a depression for an included thermal pad for optimum thermal contact with the enclosure surface. A series of English and Metric mounting holes are available for installation. A mounting tab accessory kit enables convenient installation from the inside of the enclosure to eliminate concerns of violating the enclosure's environmental integrity.

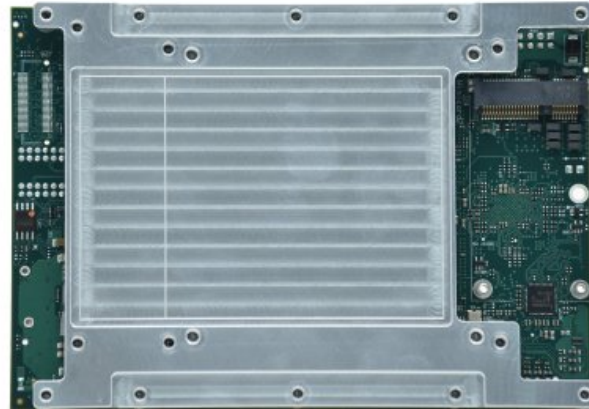

Heat spreader on bottom side

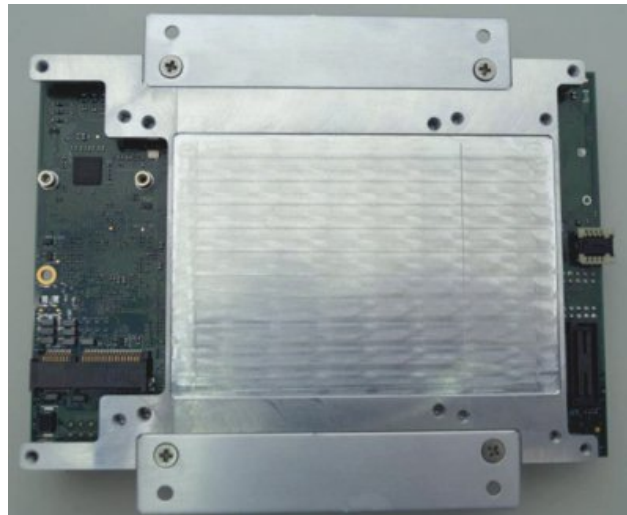

Heat spreader with optional mounting tabs installed for interior mounting operation

Rugged Memory

Venus includes 4GB of DDR4-2133MHz memory soldered on board for enhanced ruggedness. The memory size may be upgraded to as high as 20GB using readily available DDR4 SODIMM modules in 4GB, 8GB, and 16GB capacity. For rugged applications we offer our unique RSODIMM rugged memory modules, which are designed to withstand MIL-STD-202G shock and vibration specifications. RSODIMM modules are exactly like standard SODIMM modules except they have a small PCB extension that provides two mounting holes to fix the module to the SBC more reliably.

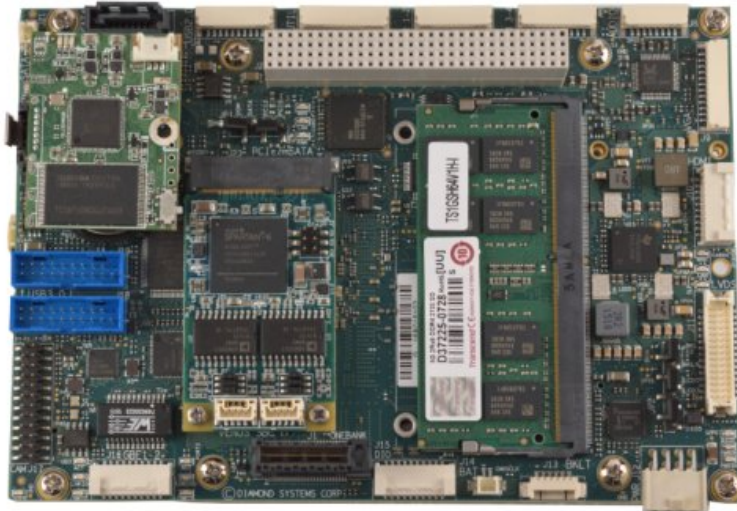

Standard SODIMM installed for memory expansion

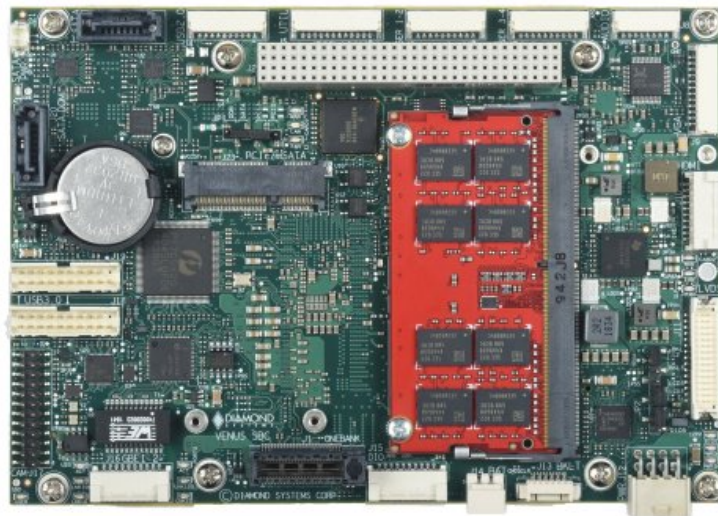

Diamond's unique rugged RSODIMM memory module installed on Venus

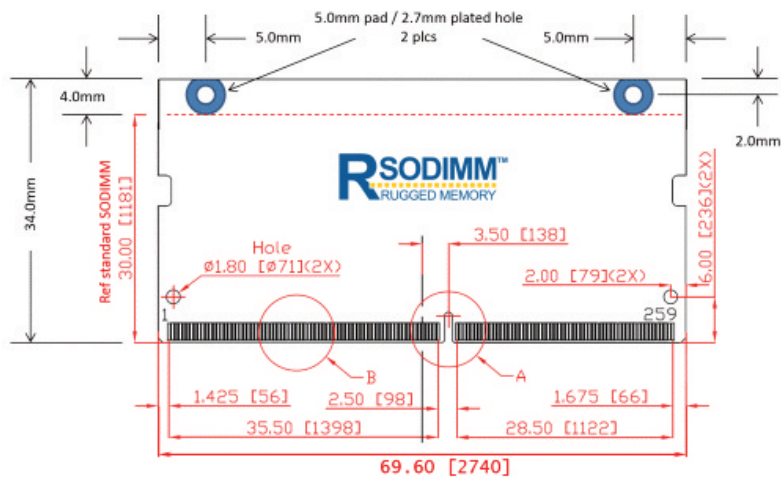

RSODIMM mechanical drawing

◆ Specifications

Features

Processor	"Kaby Lake" 7th Gen Core i7-7660U 2.8GHz, 2 cores 4 threads
Chipset	Integrated onto processor package
Memory	Up to 20GB: 4GB memory down + socket for 4/8/16GB DDR4-2133 SODIMM / RSODIMM
Graphics	3 independent displays: HDMI, VGA, and LVDS, max resolution 4096 x 2304
Ethernet	2 Gigabit ports: 1 from chipset with i219 PHY, 1 from i210 on PCIe x1 lane, on-board LEDs for status
USB	4x USB 3.0/2.0 ports on Intel standard USB 2.0 connectors + 2x USB 2.0 on separate connector 2x USB 2.0 via PCIe/104 OneBank expansion connector 2x USB 2.0 via PCIe MiniCard sockets
Serial	4x multiprotocol RS-232/422/485, all features programmable including termination
Audio	HDA audio with Line in, Line out, and Mic in, ALC892 CODEC
Digital I/O	16 lines with bitwise programmable direction, configurable 3.3V/5V logic levels, and configurable pull-up/down resistors
Mass storage	3 SATA interfaces: SATA DOM, Standard SATA, mSATA support in one MiniCard socket
Security	TPM module Infineon SLB 9670XQ2.0
Expansion	MiniCard sockets: 1 socket supports full size PCIe/USB MiniCard and mSATA modules 1 socket supports full / half size PCIe/USB MiniCard OneBank Plus (PCIe/104 + PCI-104) socket with 22mm stacking height: Supports up to 3 PCIe x1 Type 1 / Type 2 / OneBank I/O modules + up to 2 USB interface modules Supports up to 4 PCI-104 expansion modules
Connectors	Latching, JST GH / GHD series
Form factor	"3.5 inch" form factor: 5.75" x 4.0" / 146 x 102mm
Weight	281g/ 9.9oz
Cooling	Conduction cooling heat spreader on bottom
Input voltage	9-18VDC
Power consumption	14W under typical operating conditions
Operating Temp	-40° to +85°C

◆ Models and Accessories

Venus

Available Models:

VNS776KL-4GD	Venus SBC, i7-7660U 2.8GHz CPU, 4GB RAM soldered on board RSODIMM rugged memory expansion	Available
DK-VNS776KL-WE1064	Venus SBC development kit, includes VNS776KL-4GD SBC, Windows 10 64-bit OS on SATA DOM, and cable kit	Available
DK-VNS776KL-LNX64	Venus SBC development kit, includes VNS776KL-4GD SBC, Ubuntu Linux 64-bit OS on SATA DOM, and cable kit	Available
SDK-VNS766-WE10	Venus SBC software development kit, includes Windows 10 OS on SATA DOM	Available
SDK-VNS766-LNX	Venus SBC software development kit, includes Linux OS on SATA DOM	Available

Please [login](#) or [signup](#) for an online quote request.

Cables and accessories

Available Models:

CK-VNS-05	Venus SBC Cable Kit, With HDMI Cable
6980514	Cable Utility, 1x12 1.25mm conn to 2x6 2mm IDC Socket, 12"L Ribbon
6980517	Cable, DAQ, GHDR-20V-S to DB-37F, 12"L Ribbon
6980507	Cable VGA, JST GHR 1x12 to DE15F VGA Pnl Mt, 12"L Ribbon
6980508	Cable, Audio, JST GHR 1x8 to x2 3.5mm Pnl Mt Jacks and x1 3.5mm Mono Jack, 12"L
6989101	SATA Cable, 7-Pin Data, Straight to Right Angle, 500mm
6980513	Cable, Dual Ethernet, 2x10 1.25mm to 2x RJ-45 Pnl Mt, 12"L
6980500	Cable, Dual Serial, JST GHR 1x10 to 2x DB9M, 12" Ribbon
6980610	Dual USB 3.1 type A cable with latching 2x10 2mm board connector
6980503	Cable, Dual USB 2.0, 1.25mm 1x10 to 2x USB Type A F Pnl Mt, 12"L
6980524	Cable, External Battery, Molex Spox 2 Pos to Tinned Leads, 12" L
6980512	Cable Power, 2x4 0.1" Latching to Discrete Wires, 15"L
6980519	Cable, HDMI to GHDR-20V 2x10 1.25mm